

 **DIOXCARE**

# DX700

CO<sub>2</sub> Meter

**User manual**



## ENGLISH

**Table of Content**

Overview .....	2
Safety and maintenance .....	3
Appearance structure .....	4
Button functions .....	5
Operating instructions .....	6
1. Power on/off .....	6
2. Switch the temperature unit .....	6
3. Turn on/off the alarm .....	6
4. Alarm value setting .....	6
5. View historical records .....	6
6. Setting interface operation .....	7
7. View historical trend graph .....	7
8. Generate a PDF file, connect to a computer, and format a disk .....	10
Specifications .....	12
Carbon dioxide concentration level .....	13
Analysis of commonly seen troubles .....	14

## Overview

The carbon dioxide Dioxcare detector detects the carbon dioxide gas of the onsite environment through absorption principle of infrared light sources.

The product has the characteristics of temperature, humidity and CO2 tendency chart, 999 groups of data record, 3.2" TFT full color display, alarm setting, data record of time interval measurement, real-time date and time, chargeable lithium battery or separate external USB charging.

## The application field of carbon dioxide detector:

### 1. Public site

The densely populated place such as meeting room, classroom, exhibition hall, hospitals, department stores, bars, hotel, airport, railway station and entertainment hall, etc. the carbon dioxide detector may be used for ventilation

control and environment quality monitoring So, it is used to guarantee body health.

### 2. Agriculture

The carbon dioxide may be used for plant photosynthesis. Therefore, it is widely used for agriculture. The air fertilizer with proper concentration may improve output of agricultural crops. When the concentration of carbon dioxide is not sufficient, air fertilizer may be used. It will give great help for whether the vegetable growth or improvement of vegetable.

### 3. Animal husbandry

The air quality concerns healthy growth of animals. If the air is turbid for a long time and the concentration of carbon dioxide is high and ventilation is not provided, the animal will get ill or epidemic disease may burst out. Therefore, installation of carbon dioxide detector at livestock farm may prevent occurrence of animal epidemics.

#### 4. Industry

The carbon dioxide detector is widely used in the Industry such as wastewater treatment, factory building, workshop, temperature, cleaning room, production safety and all types of Industries. Especially, it is very necessary to monitor the carbon dioxide in borehole operation. The carbon dioxide detector is used generally in metal processing, paper pulp and paper making, cleaning and solvent extraction as well as lower temperature cleaning and carbon dioxide relevant Industry.

#### Safety and maintenance

1. It is recommended to do a manual calibration before starting to use the CO2 meter so that it will perform the measurements correctly.
2. Please do not use the meter under a dusty or corrosive gas environment so as not to result in shorter service life or damage.
3. When the battery icon on the display screen is blank or red, please charge the battery in a timely manner. When it lies idle for long, it is required to take out the battery.
4. Please do not store or use the meter under a high temperature, high humidity, flammable, explosive and strong electromagnetic field.
5. During the care of it, please use soft cloth and neutral cleaning agents to clean the housing. Never use abrasives or solution so as not to cause corrosion to the housing and damage to the meter.

## Appearance structure

1. Airflow window
2. Temperature and humidity sensor
3. Display screen
4. Operation button
5. USB interface
6. Airflow window
7. Battery compartment

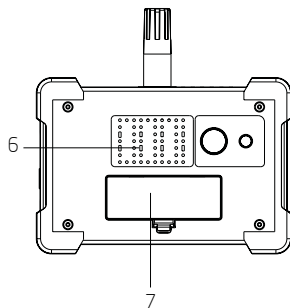
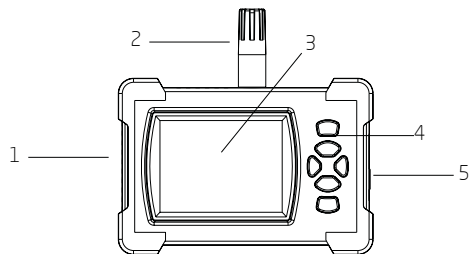

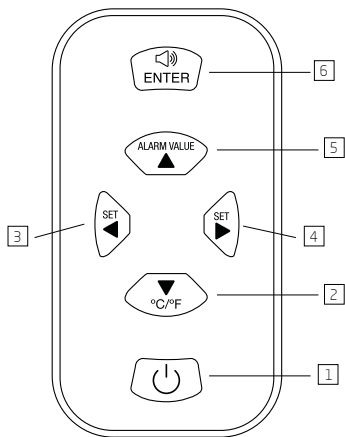

**Caution:** During a test, please do not block the airflow window with any matter.



## Button functions

- 1** ON/OFF
- 2** **Test mode:** to convert temperature units  
**Set mode:** Move Down menu
- 3** **Measurement mode:** switch historical tendency interface  
**Set mode:** shift or reduce data
- 4** **Test mode:** Records or Setting  
**Set mode:** to shift or add data
- 5** **Measurement mode:** alarm setting interface  
**Set mode:** Move Up menu
- 6** **Measurement mode:** open or close the alarm sound  
**Set mode:** Set mode: shift or reduce data

## Operating instructions

1. **Power on/off:** press the key  to power on, and press the key  to power off in the measurement interface.

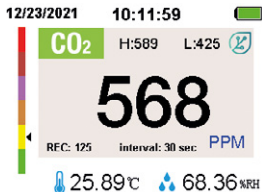







Measurement Interface

2. **Switch the temperature unit:** press the key  in the measurement interface to switch the °C/°F unit.

3. **Turn on/off the alarm:** press the key  in the measurement interface to turn on/off the alarm





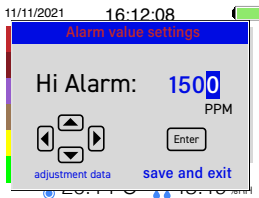

function. The symbol  is displayed at the top of the screen when the alarm function is turned on, and this symbol is not displayed when the alarm function is turned off.

4. **Alarm value setting:** press the key  in the measurement interface to open the alarm value setting interface. Press the key  /  to select the value, press the key  /  to increase or decrease the value, press the key  to save and exit after setting.



Alarm Setting Interface



**5. View historical records:** Press the key  once in the measurement interface to switch to the historical record interface. Press the key  in the historical record interface, the page number is displayed at the bottom of the interface, press the keys  and  to move left and right, press the keys  and  to adjust the page number, and press the key  again to end the adjustment. (Max / Min mode is used to view the minimum and maximum CO2 values in the historical records).





#### < Records >

NO	001	002
Date	10/29/2020	10/29/2020
Time	12:23:17	12:23:27
CO2	595 PPM	738 PPM
Temp	23.24	35.79
RH	76.81	78.41













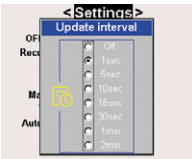





**6. Setting interface operation:** Press the key  twice in the measurement interface to switch to the setting interface.



















#### < Settings >

OFF Backlight:	OFF
Record interval:	ENTER
Backlight:	50%
Data Clear:	ENTER
MaxMinMode:	OFF
Time&Data:	Enter
Auto shutdown:	OFF
Calibration:	Enter
Reset:	NO

**Setting parameters:** Press the key  in the setting interface, and the setting items are in a selectable state. At this time, press the key  or  to select the item to be set. For the operation method, refer to the following table please. After the setting is completed, press the key  to exit the setting, and press the key  to return to the measurement interface.

**Warning:** Device has been calibrated at the factory, however it is highly recommended to do a manual calibration before starting to use it. The user can calibrate it periodically if desired. The first time the CO2 Sensor can take up to 10 days to fully balance and present accurate data. Calibration must be carried out in an outdoor environment.

Setting options	Optional parameters	Setting method
<b>OFF Backlighting</b>	OFF / 1min / 5min / 10min / 30min / 1hour	Press the key  /  / 
<b>Record interval</b>		Press key  /  /  to up setting pop options, press the key /  to  select and  press the key to return
<b>Backlight</b>	25% / 50% / 75% / 100%	Press the key  /  / 
<b>Data Clear</b>	Yes / No	Press the key  /  / 
<b>Max Min Mode</b>	OFF / ON	Press the key  /  / 

<b>Time&amp;Data</b>	Data:2020-10-30 Time: 10 : 01 : 18	Press the key  x to pop up the time setting page, press the key  /  again to select, and press the key  /  to adjust. Press the key  to save the settings and return.
<b>Auto shutdown</b>	OFF/15min/30min/45min/ 1hour/2hour/4hour/8hour	Press  /  /  / 
<b>Calibration</b>	Calibrate in an outdoor environment. Calibration time is 600 seconds in the countdown and automatically returns to the measurement screen after the calibration and shows a CO2 value of about 420 ppm.	Press  /  /  /  Press  again to cancel
<b>Reset</b>	Yes / No	Press  /  /  / 

## 7. View historical trend graph

In the measurement interface, press the key  once to open the historical trend graph (provided that the product saves measurement data, otherwise the historical trend graph interface will not be displayed).

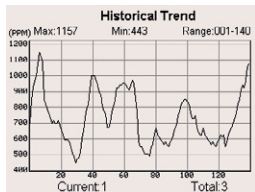

View Historical Trend Graph

## 8. Generate a PDF file, connect to a computer, and format a disk.



Press the key  twice in the measurement interface to open the interface as shown in the



figure below. In this interface, you can generate a PDF file, connect to a computer, and format a disk.

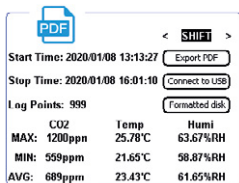

**Generate PDF file:** Press the key  to select "Export PDF", press the key  to generate PDF file.

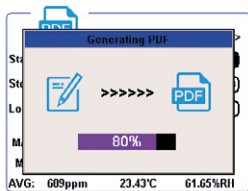

Generating PDF File

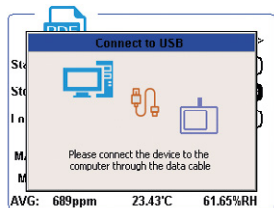

**Connect to a computer:** Use a USB data cable to connect the product to the computer. Press the key  to select "Connect to USB", and press the key  to confirm the connection. After the connection is successful, the computer will display a disk named "CO2 METER". Open the disk to view and copy the previously generated PDF file.







Connect to Computer Interface



Computer Recognizes Disk Successfully

**Disconnect:** Short press the power key of the product to disconnect the product from the computer, press the key  to select "SHFT", and press the key  to return to the measurement interface.

**Format disk:** Press key  to select "Formatted disk", press key  to pop up a dialog box, press key  to format the disk and press key  to cancel formatting the disk.

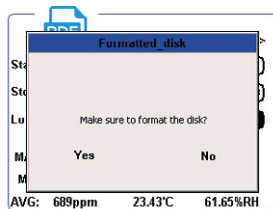

Format Disk Interface

## Specifications

Parameter	Indicators
Carbon dioxide concentration measurement scope	0-9999PPM
Resolution ratio of carbon dioxide concentration	1PPM
Accuracy	± 40 ppm ± 3% of reading
Working temperature range	-10~+60 °C (-4~+140°F)
Working humidity range	0-99 %RH
Storage temperature range	40-+80 °C
Temperature measurement range	-20-60 °C
Temperature measurement accuracy	±1°C
Temperature resolution	0.01°C/F
Humidity measurement range	0-100%RH

Parameter	Indicators
Humidity measurement accuracy	±2%RH
Humidity resolution	0.01%RH
Power supply	Built in with demountable 3.7V/18650 cylinder battery or externally connected 5V USB power
Working current	90mAh~280mAh
Battery service life	3000mAh capable of continuous work at >24 hours
Charging duration	3 hours
Auto power off	Capable of being set (with factory default automatic power off in 30 minutes)
Record groups	999 groups
Net weight (g)	191g
Size (mm)	140*134*33

## Carbon dioxide concentration level

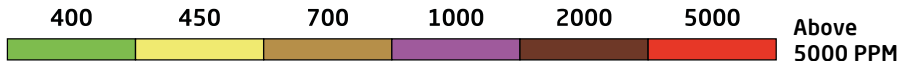

**400-450PPM** (excellent) usual outdoor air level.

**450-700PPM** (Good) The typical value of living space with good ventilation. **700-1000PPM** (Minor pollution) The living environment with poor ventilation.

**1000-2000PPM** (middle level pollution) insufficient oxygen makes people sleepy and the air that may cause complaint.

**2000-5000PPM** (serious pollution) The stagnant, old and muggy air. The phenomenon of headache, drowsiness with distraction, declination of attention, tachycardia and slight nausea.

**Above 5000PPM** (serious pollution) may cause serious anoxia or lead to perpetual cerebral injury, coma or even death when exposing in air.

## Analysis of commonly seen troubles

### 1. The carbon dioxide concentration data in the air is not accurate.

**Analysis 1:** The concentration content of the environment is not stable. At the time of measurement, place the device in the same place for a period of time.

**Analysis 2:** There are sundries, dirt at the sampling window of carbon dioxide sensor. The air flow ventilation window is blocked.

**Analysis 3:** the carbon dioxide sensor has deviation. It needs to calibrate the equipment again.

### 2. Incorrect temperature and humidity

**Analysis 1:** Analysis of existence of impurities or dirt or filth at the sampling window of the temperature and humidity sensor.

**Analysis 2:** The ventilation window has been blocked by something.

### 3. Date and time is not accurate

**Analysis 1:** caused by too low button battery level inside the equipment.

### 4. Failure in power on

**Analysis 1:** The battery has no power or is damaged. Use the USB socket for power supply. If power can be on, and if there is change any change in the power check, it indicates that there is no power in the battery. If there is no change, the OK icon is displayed only indicating the battery has been damaged.

**Analysis 2:** Battery +/- polarity is mounted reversely. It is required to note that the non-protruding contact at one end of the battery must be "-" polarity, and that the protruding contact at one end must be "+" polarity. The following figure can be referenced.





# DIOXCARE

Manufactured in PRC

Imported by: Smartcare Services S.L

VAT: ESB55333447

info@dioxcare.com

[dioxcare.com](https://www.dioxcare.com)

